

M63802P/FP/GP/KP

7-UNIT 300mA TRANSISTOR ARRAY

DESCRIPTION

M63802P, M63802FP, M63802GP and M63802KP are seven-circuit Single transistor arrays. The circuits are made of NPN transistors. Both the semiconductor integrated circuits perform high-current driving with extremely low input-current supply.

FEATURES

- Four package configurations (P, FP, GP and KP)
- Medium breakdown voltage ($BV_{CEO} \geq 35V$)
- Synchronizing current ($I_{C(max)} = 300mA$)
- With zener diodes
- Low output saturation voltage
- Wide operating temperature range ($T_a = -40$ to $+85^\circ C$)

APPLICATION

Driving of digit drives of indication elements (LEDs and lamps) with small signals

FUNCTION

The M63802P, M63802FP, M63802GP and M63802KP each have seven circuits consisting of NPN transistor. The transistor emitters are all connected to the GND pin (pin 8). The transistors allow synchronous flow of 300mA collector current. A maximum of 35V voltage can be applied between the collector and emitter.

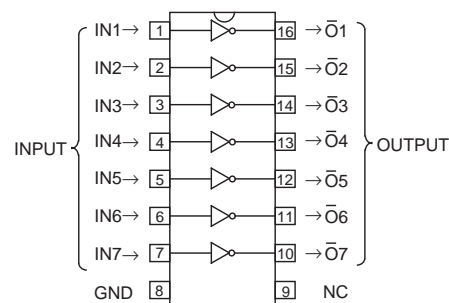
PIN CONFIGURATION

Package type 16P4(P)
16P2N-A(FP)
16P2S-A(GP)
16P2Z-A(KP) NC : No connection

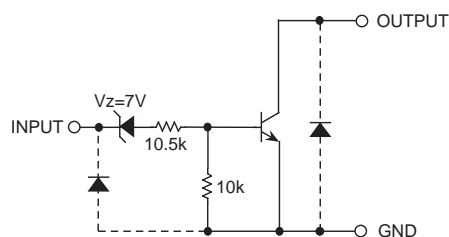
CIRCUIT DIAGRAM

The seven circuits share the GND.

The diode, indicated with the dotted line, is parasitic, and cannot be used.

Unit: Ω

ABSOLUTE MAXIMUM RATINGS (Unless otherwise noted, $T_a = -40 \sim +85^\circ C$)

Symbol	Parameter	Conditions	Ratings	Unit	
V_{CEO}	Collector-emitter voltage	Output, H	-0.5 ~ +35	V	
I_C	Collector current	Current per circuit output, L	300	mA	
V_i	Input voltage		-0.5 ~ +35	V	
P_d	Power dissipation	$T_a = 25^\circ C$, when mounted on board	M63802P	1.47	W
			M63802FP	1.00	
			M63802GP	0.80	
			M63802KP	0.78	
T_{opr}	Operating temperature		-40 ~ +85	$^\circ C$	
T_{stg}	Storage temperature		-55 ~ +125	$^\circ C$	

Jan. 2000

M63802P/FP/GP/KP

7-UNIT 300mA TRANSISTOR ARRAY

RECOMMENDED OPERATING CONDITIONS (Unless otherwise noted, Ta = -40 ~ +85°C)

Symbol	Parameter	Test conditions	Limits			Unit	
			min	typ	max		
Vo	Output voltage		0	—	35	V	
Ic	Collector current (Current per 1 circuit when 7 circuits are coming on simulta- neously)	M63802P	Duty Cycle no more than 45%	0	—	250	mA
			Duty Cycle no more than 100%	0	—	160	
		M63802FP	Duty Cycle no more than 30%	0	—	250	
			Duty Cycle no more than 100%	0	—	130	
		M63802GP	Duty Cycle no more than 24%	0	—	250	
			Duty Cycle no more than 100%	0	—	120	
		M63802KP	Duty Cycle no more than 24%	0	—	250	
			Duty Cycle no more than 100%	0	—	120	
VIN	Input voltage		0	—	30	V	

ELECTRICAL CHARACTERISTICS (Unless otherwise noted, Ta = 25°C)

Symbol	Parameter	Test conditions	Limits			Unit
			min	typ	max	
V (BR) CEO	Collector-emitter breakdown voltage	ICEO = 10μA	35	—	—	V
VCE(sat)	Collector-emitter saturation voltage	IIN = 1mA, IC = 10mA	—	—	0.2	V
		IIN = 2mA, IC = 150mA	—	—	0.8	
VIN(on)	"On" input voltage	IIN = 1mA, IC = 10mA	13	19	23	V
hFE	DC amplification factor	VCE = 10V, IC = 10mA	50	—	—	—

SWITCHING CHARACTERISTICS (Unless otherwise noted, Ta = 25°C)

Symbol	Parameter	Test conditions	Limits			Unit
			min	typ	max	
ton	Turn-on time	CL = 15pF (note 1)	—	140	—	ns
toff	Turn-off time		—	240	—	ns

NOTE 1 TEST CIRCUIT

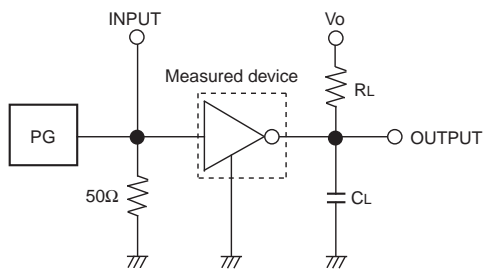

TIMING DIAGRAM

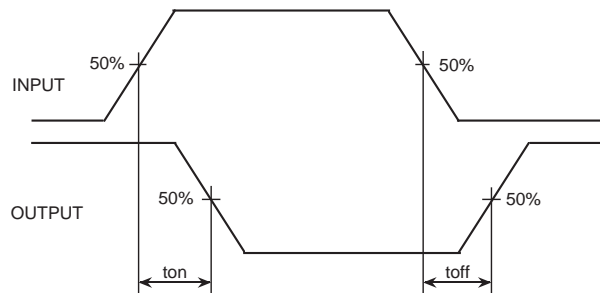

- (1) Pulse generator (PG) characteristics : PRR = 1kHz,
tw = 10μs, tr = 6ns, tf = 6ns, Zo = 50Ω, VIH = 18V
- (2) Input-output conditions : RL = 220Ω, Vo = 35V
- (3) Electrostatic capacity CL includes floating capacitance at
connections and input capacitance at probes

M63802P/FP/GP/KP

7-UNIT 300mA TRANSISTOR ARRAY

TYPICAL CHARACTERISTICS

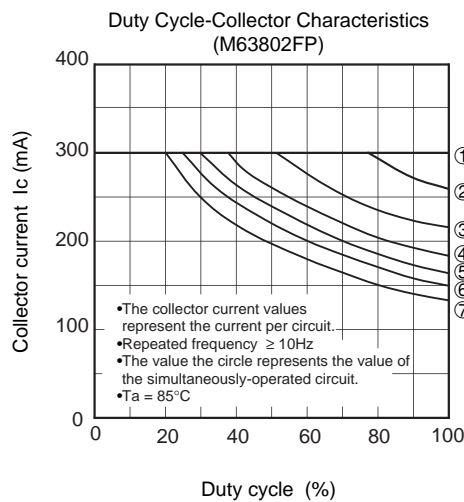
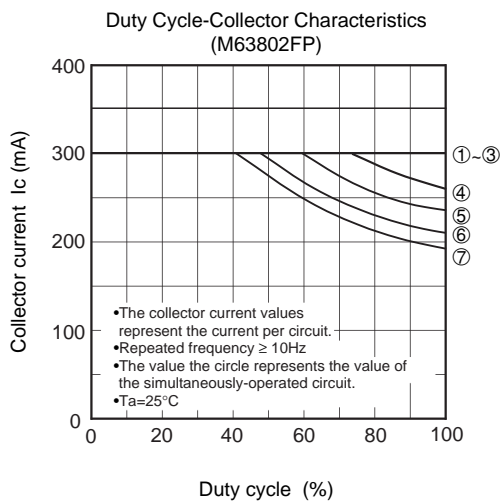
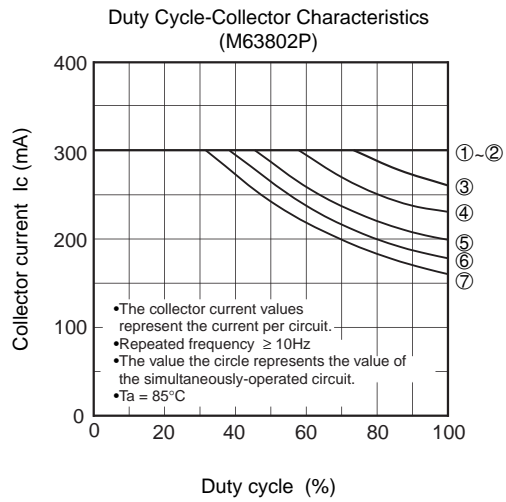
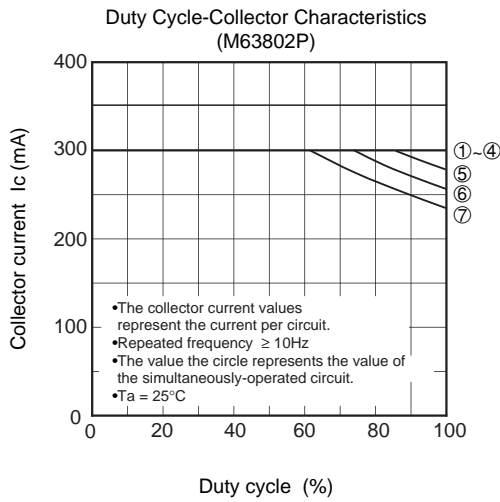
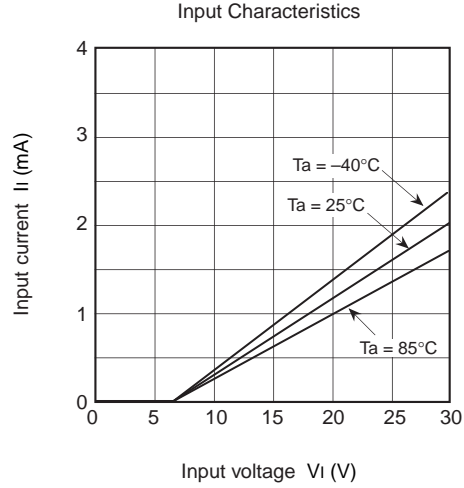
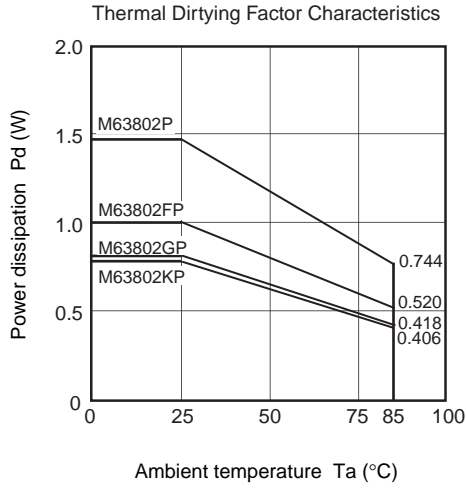

M63802P/FP/GP/KP

7-UNIT 300mA TRANSISTOR ARRAY

